

TIRCO

Uw partner voor kwaliteits trailercomponenten

CAMOZZI
Automation

SERIES 9000 **AIRBRAKE FITTINGS**



SOLUTIONS FOR THE TRANSPORTATION SECTOR



Being one of our three strategic business sectors, Camozzi Automation offers the **Transportation** industries a wide range of products. These products are ready for use and their robust construction means they are able to operate in the harshest conditions, thus assuring reliable and efficient operation in order to keep you moving.

In close cooperation with our customers and partners, we develop and deliver both standard products and customised solutions, which all offer **high performance**, smart and effective designs and **excellent quality**.

Developing products that can operate in extreme temperatures, dirty or corrosive environments and while exposed to high mechanical loads and/or vibrational stress is **the mission** that drives our experienced and motivated engineers.

Our worldwide customer base consists of leading OEMs, Tier 1 System Suppliers, Component Suppliers and well-known businesses in the Aftermarket & Repair sector.

We always follow one principle:
"Customer first - always".

A **remarkable level of design** and production know-how, combined with an enterprising spirit and a commitment to **listen to customers**, are our keys to success in the transportation sector.

Camozzi Automation's long service to the transportation sector means it supplies equipment and expertise on many different types of vehicles, including **On-Road, Off-Highway** and **Rail**.

We are active in all the **major application areas**, including Chassis, Cabin & Body, Mobile Automation and the Powertrain.

Our offering starts from fittings for multiple fluids like air, fuel, water, oil or grease, and extends over a wide range of gas and fluid control valves to pneumatic and electric actuators, FRL units and other complementary components. This comprehensive range means we are always **the right partner for your project**.

Connection or Actuation, On/Off or Proportional, Mechanical or CAN-Bus, IATF 16949 or IRIS, **we talk and understand your language**.

**TRUCK
& TRAILER**



**BUS
& COACH**



RAILWAY

















**OFF
HIGHWAY**





























**PASSENGER CAR
& LIGHT DUTY**









General index

Straight connectors			Swivel range New		
		Page			Page
	Mod. 9512 Straight fittings	5		Mod. D2912 Swivel studs	13
	Mod. D6512 Straight fittings	5		Mod. 9707 Anti-rotation ring	13
	Mod. 9510 Straight fittings	6		Mod. 9520 Swivel elbow fittings	14
	Mod. 9463 Fittings with female thread	6		Mod. 9430 Swivel tee fittings	14
	Mod. 9590 Bulkhead connectors	6		Mod. 9440 Swivel tee fittings	14
	Mod. 9590 Bulkhead connectors Mod. 9590 with 24° cone	7		Mod. D2220 Swivel elbow adaptors	15
	Mod. 9592 Bulkhead connectors	7		Mod. D2260 Swivel tee adaptors	15
	Mod. 9580 Connectors	7		Mod. D2270 Swivel tee adaptors	15

Shaped non-swivel connectors			Adaptors & Valves		
		Page			Page
	Mod. 9502 Elbow fittings	8		Mod. D2502 and D2512 Bulkhead connectors	16
	Mod. 9500 Elbow fittings	8		Mod. D2532 Reducer	16
	Mod. 9412 Tee fittings	9		Mod. D2602 Hose adaptors	16
	Mod. 9410 Tee fittings	9		Mod. D2022 Elbow adaptors	17
	Mod. 9422 Tee fittings	10		Mod. D2062 Tee adaptors	17
	Mod. 9420 Tee fittings	10		Mod. D2072 Tee adaptors	17
	Mod. 9102 135° fittings	11		Mod. D2003 Tee adaptors	18
	Mod. 9540 Tee fittings	11		Mod. D2003-S01 Tee adaptors	18
	Mod. 9555 Fittings	11		Mod. D2032 Cross adaptors	18
	Mod. 9450 Y fittings	12		Mod. D2077 Bilateral tee adaptors	18
	Mod. 9402 Elbow fittings	12		Mod. D3043 Adaptors	19

Adaptors & Valves		Page
	Mod. D2612 Taps	19
	Mod. VPC2 Test point valve	19
	Mod. VPC2 Bulkhead with test point & tube connection	20
	Mod. VDC2 Drain valve	20
	Mod. V604 Tyre inflator valve	20

Accessories		Page
	Mod. TRN Tubes	21
	Mod. DRK Tube disconnecting	21
	Mod. PNZ and PNPZ Tube cutter tool	21
Assortment boxes / Repair Kits		Page
	TRUCK-DCASE/6000 Repair kit with Series 6000 fittings	22
	TRUCK-DCASE/9000 Repair kit with Series 9000 fittings	22
	TRUCK-DCASE/9000+6000 Repair kit with Series 9000 and Series 6000 fittings	22

Series 9000 Airbrake Fittings



Series 9000 fittings have been designed to connect DIN 74324 or ISO 7628 tubing in the pneumatic brake systems of commercial vehicles. They offer excellent reliability and ease of assembly and the range includes a special release tool for disconnecting tubes from the fittings.

Each fitting has a rubber cap for the protection of the internal parts against dirt and water ingress.

Because of the very compact design, Series 9000 fittings are the best choice for difficult or space-constrained situations.

Similarly, the release tool also requires only a minimum amount of space for use.

Series 9000 fittings are TÜV certified and produced according to IATF 16949: 2016 standards.

General data

Thread type	Metric acc. ISO965 / Conical NPTF acc. ANSI B1.20.3	Materials	COMPONENT	MATERIAL
Media	Compressed air (other fluids, please contact our technicians)		1 = Body	Brass
Operating pressure	Up to 16 bar (review also tube specifications)		2 = Support Tube	Composite
Operating temperature	-50°C up to 100°C (review also tube specifications)		3 = Tube O-Ring	NBR
Tubes	Designed for use with Hytrel® or polyamide tubing, compliant with standards DIN 73378, DIN 74324 or ISO 7628		4 = Collet	Brass
			5 = Dirt Seal	NBR
			6 = Thread O-Ring	NBR
			7 = Locking Nut	Brass
			8 = Swivel Body	Brass
			9 = Swivel O-Ring	NBR
			10 = Seeger Ring	Stainless Steel
			11 = Protection Cap	Biodegradable Composite

Straight connector

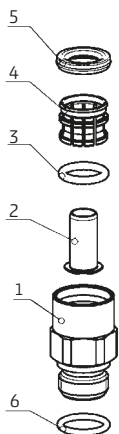

Shaped connectors (fixed/swivel)

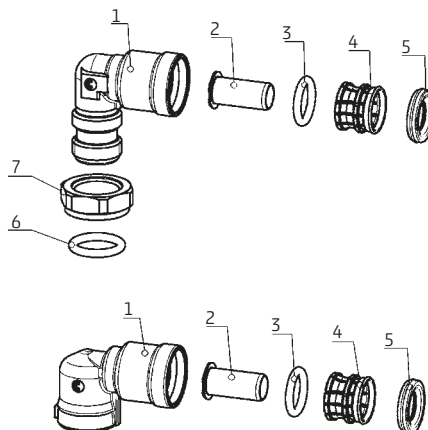

Swivel stud

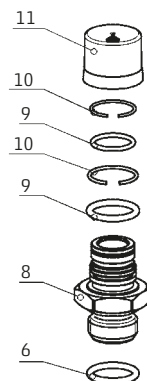

Assembly and removal of the tube

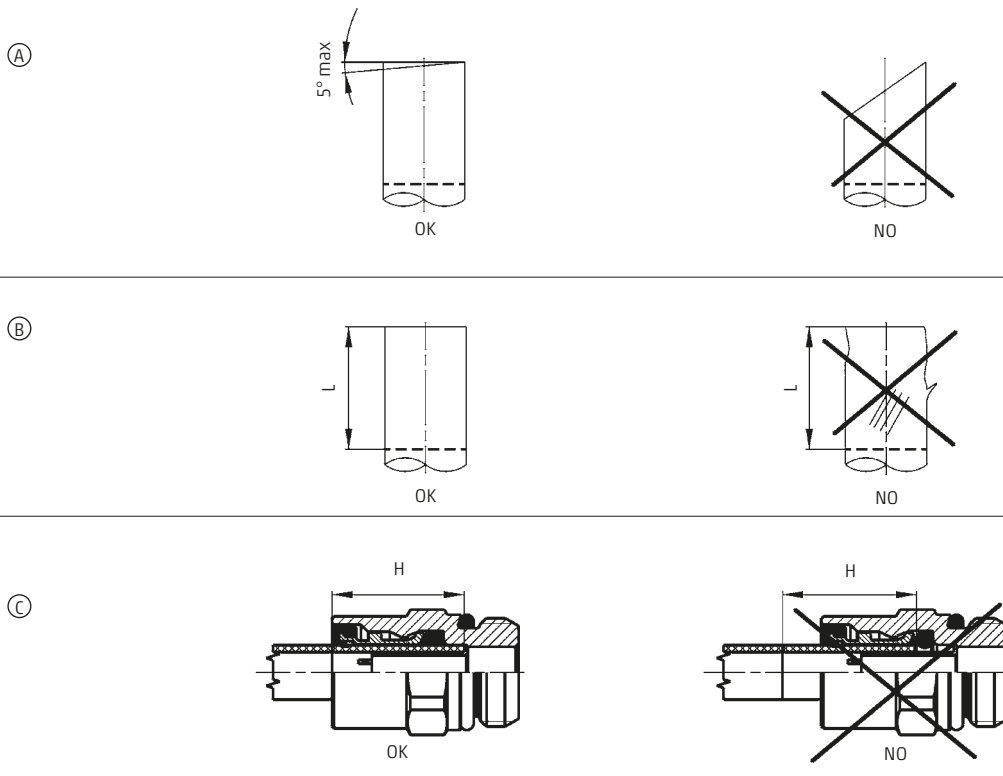

To guarantee correct, safe and tight connection, it is necessary to cut the tube in the correct way (Picture A). The cutting angle should not exceed 5°, thus we recommend using a tube cutting tool, such as the model PNZ shown at the end of this catalogue. The outer surface of the tube needs to be smooth and free from any kind of damage or dirt (Picture B). When inserting the tube, make sure to push it into the fitting down to the tube stop (Picture C). The correct insertion length is specified for every tube size/fitting and can be found in the table to the right (Assembly length H). We recommend marking the insertion depth on the tube with a pen or tape before assembling in order to visually ensure proper insertion.

Tube	Outer diameter (mm)	Inner diameter (mm)	Assembly length H (mm)
4x1	4	2	18,5
6x1	6	4	17,5
8x1	8	6	19,5
10x1	10	8	21
10x1,5	10	7	21
12x1,5	12	9	21,5
15x1,5	15	12	25
15x2	15	11	25
16x1,5	16	13	27,5
16x2	16	12	27,5
18x2	18	14	27,5

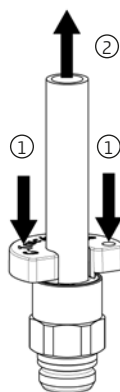

To remove the tube from the fitting, use the Series 9000 DRK release tool at the end of this catalogue. Hook it onto the tube and press the protection cap down to release the tube so that you can pull it out of the fitting.

Attention: Do not try to remove the tube from the fitting when the system is still pressurised. Make sure you have released all the air pressure before you remove the tube.

Tube assembly and disassembly must be carried out by a technician who is trained and has detailed knowledge of the air brake system and the Series 9000 fittings.

Please ensure mounting torques for straight connectors, straight studs and the fixation nuts of shaped connectors meet the values shown in the table on the right.

Thread	Torque force (Nm)
M10X1	11 - 15
M12X1.5	15 - 22
M14X1.5	19 - 23
M16X1.5	24 - 33
M18X1.5	27 - 33
M22X1.5	36 - 44

Assembly of shaped Non-Swivel Connectors

To ensure a tight and secure connection between the fitting and the threaded port of the component in the pneumatic system, please install following this procedure:

1. Screw the nut upwards until you reach the mechanical stop (do not tighten the nut against the stop with a tool, simply position the nut by hand, as shown in the picture).

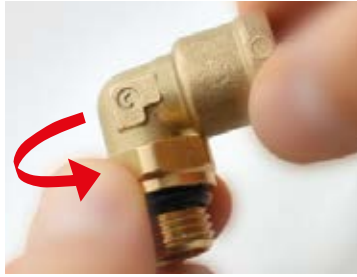

2. Screw the fitting into the threaded port until the O-ring seal touches the surface of the port. This can be done by hand or using a tool. We recommend you do this by hand (Picture A) to maintain feel and identify once the correct position is reached.



3. Bring the fitting into the final, desired position rotating it by a maximum of 180° clockwise or anti-clockwise.



4. Fix the position you have defined for your fitting with one hand and tighten the connection by screwing the nut downwards until you have reached the recommended torque (see table on the previous page).



5. The assembly is now complete.



Assembly of Swivel Connectors

For Swivel Connectors, please install manually according to the following instructions. **Attention:** Swivel connectors should not be used in applications with relative movement (e.g. connections between truck & trailer or between axle and chassis).

1. Mount the stud onto the port (please refer to the maximum torque forces on the previous pages). We recommend removing the cap immediately before you mount the female part to the stud in order to prevent dirt on or damage to the O-rings.



2. Position the female part on the stud. If you want to use an anti-rotation lock, attach this to the female part before you connect to the stud.



3. Now press down the upper part completely. The assembly is now complete.

Note: This connection cannot be disassembled again.



4. The swivel connector is now completed and ready for the tube to be inserted. The connector can be rotated to the necessary position (360° swivelling). If you have added a rotation lock and the connector is still swivelling, this is because you have not yet engaged the lock.



5. To engage the rotation lock, bring the upper part to a position that lets you press it down to interlock with the hexagon of the stud. Then press the locking ring down. The connector is now fixed in position.

Attention: The lock is a positioning support for line routing. It is not meant to withstand excessive bending forces



Straight connectors

■ Straight fittings Mod. 9512

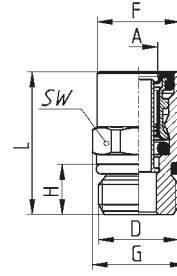

SERIES 9000

CHARACTERISTICS									
Mod.	A	D	F	G	H	L	SW	Weight (g)	Pack. (pcs)
9512 6-M10X1	6x1	M10X1	13,8	15	7	27,5	14	17,5	10
9512 6-M12X1,5R	6x1	M12X1,5	13,8	15	10	27,5	14	17,5	10
9512 6-M14X1,5R	6x1	M14X1,5	13,8	15	10	26,5	14	19,5	10
9512 6-M16X1,5R	6x1	M16X1,5	13,8	17	10	19,5	14	17,5	10
9512 8-M10X1	8x1	M10X1	16,5	18,5	7	30	17	26,5	10
9512 8-M12X1,5R	8x1	M12X1,5	16,5	18,5	10	32	17	28,5	10
9512 8-M14X1,5R	8x1	M14X1,5	16,5	18,5	10	29	17	26	10
9512 8-M16X1,5R	8x1	M16X1,5	16,5	18,5	10	28,5	17	29,5	10
9512 8-M22X1,5R	8x1	M22X1,5	16,5	23	10	21	19	39,5	10
9512 10/7-M12X1,5R	10x1,5	M12X1,5	17,8	19,5	10	33,5	18	26,5	10
9512 10/7-M16X1,5R	10x1,5	M16X1,5	17,8	19,5	10	29,5	18	29	10
9512 10/7-M22X1,5R	10x1,5	M22X1,5	18,5	23	10	22,5	19	37	10
9512 10-M12X1,5R	10x1	M12X1,5	17,8	19,5	10	33,5	18	26,5	10
9512 10-M16X1,5R	10x1	M16X1,5	17,8	19,5	10	29,5	18	29	10
9512 10-M18X1,5R*	10x1	M18X1,5	17,8	19,5	10	29,5	18	34	10
9512 10-M22X1,5R	10x1	M22X1,5	18,5	23	10	22,5	19	37	10
9512 12-M12X1,5R	12x1,5	M12X1,5	19,8	21,5	10	35,5	20	34	10
9512 12-M14X1,5R	12x1,5	M14X1,5	19,8	21,5	10	35	20	35,5	10
9512 12-M16X1,5R	12x1,5	M16X1,5	19,8	21,5	10	34	20	37	10
9512 12-M22X1,5R	12x1,5	M22X1,5	20,5	24	10	23	22	37	10
9512 15/11-M16X1,5R*	15x2	M16X1,5	23,8	26,5	10	39	24	53,5	10
9512 15/11-M22X1,5R*	15x2	M22X1,5	23,8	26,5	10	32	24	50,5	10
9512 15-M16X1,5R	15x1,5	M16X1,5	23,8	26,5	10	39	24	53,5	10
9512 15-M22X1,5R	15x1,5	M22X1,5	23,8	26,5	10	32	24	50,5	10
9512 16/12-M16X1,5R	16x2	M16X1,5	25	30	10	42,5	27	75	10
9512 16/12-M22X1,5R	16x2	M22X1,5	25	30	10	35	27	68,5	10
9512 16-M22X1,5R	16x1,5	M22X1,5	25	30	10	35	27	68,5	10
9512 18-M22X1,5R	18x2	M22X1,5	26,8	30	10	40	27	68	10

* on request only. The previous version is available while stocks last.

■ Straight fittings Mod. D6512



Supplied without any insert

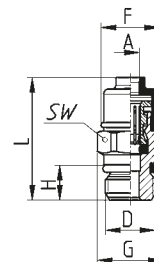

CHARACTERISTICS									
Mod.	A	D	F	G	H	L	SW	Weight (g)	Pack. (pcs)
D6512 4-M10X1	4x1	M10X1	11,7	13,2	7	24,5	12	9	10

■ Straight fittings Mod. 9510

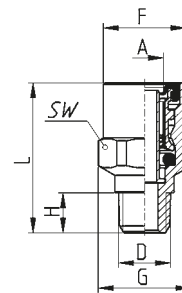

CHARACTERISTICS									
Mod.	A	D	F	G	H	L	SW	Weight (g)	Pack. (pcs)
9510 6-02	6x1	1/8 NPTF	13,8	15	8	24,5	14	16	10
9510 05-02	8x1	1/8 NPTF	16,5	18,5	8	30	17	27	10

■ Fittings with female thread Mod. 9463

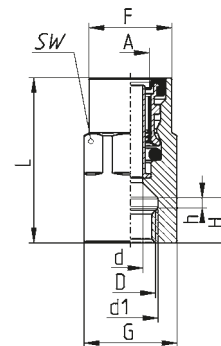

CHARACTERISTICS												
Mod.	A	D	d	d1	F	G	H	h	L	SW	Weight (g)	Pack. (pcs)
9463 6-M10X1	6x1	M10X1	5	11	13,8	15	9	2	31,5	14	27	10
9463 6-M12X1,5	6x1	M12X1,5	-	-	13,8	17	11	-	34	15	34	10
9463 6-M16X1,5	6x1	M16X1,5	-	-	15,3	21	10,5	-	34	19	51	10
9463 8-M10X1	8x1	M10X1	5	11	16,5	18,5	9	2	33	17	46	10

* on request only. The previous version is available while stocks last.

■ Bulkhead connectors Mod. 9590

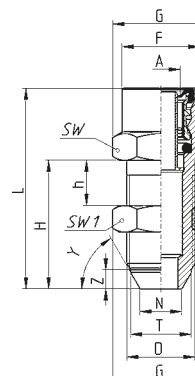

CHARACTERISTICS															
Mod.	A	D	F	G	H	h	L	N	T	Y	Z	SW	SW1	Weight (g)	Pack. (pcs)
9590 8-M18X1,5	8x1	M18X1,5	-	25,5	50	10	55,5	10,8	15,7	53	4	22	22	99,5	10
9590 12-M18X1,5	12x1,5	M18X1,5	20,5	25,5	34	4	53	11	16	60	5	22	22	83	10
9590 12-M18X1,5-S04	12x1,5	M18X1,5	20,5	25,5	33	4	52	10,8	15,7	53	4	22	-	71	10

Bulkhead connectors Mod. 9590 with 24° cone

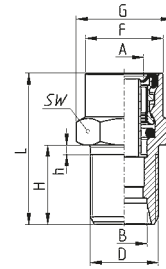

SERIES 9000

CHARACTERISTICS											
Mod.	A	B	D	F	G	H	h	L	SW	Weight (g)	Pack. (pcs)
9590 6-M14x1,5	6x1	8	M14X1,5	14,5	20	21	2,5	36	17	36	10
9590 8-M14x1,5	8x1	8	M14X1,5	16,5	20	21	2,5	43,5	17	46	10
9590 8-M16x1,5	8x1	10	M16X1,5	16,5	22	21	2,5	37	19	44	10
9590 12-M18x1,5-506	12x1,5	12	M18X1,5	20,5	25,5	21	2,5	40	22	56	10

Bulkhead connectors Mod. 9592

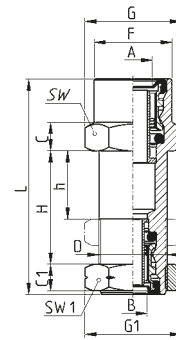

CHARACTERISTICS															
Mod.	A	B	C	C1	D	F	G	G1	H	h	L	SW	SW1	Weight (g)	Pack. (pcs)
9592 6-6-M18X1,5	6X1	6X1	6	7	M18X1,5	14,5	23	25,5	9	2,5	37,5	20	22	64	10
9592 8-8-M18X1	8X1	8X1	5,5	7	M18X1	-	25,5	25,5	30	18	43,5	22	22	77	10
9592 8-8-M20X1,5	8X1	8X1	6	5	M20X1,5	18,5	25,5	27,5	11	2,5	41	22	24	82	10
9592 12-8-M18X1	12X1,5	8/6	7,5	7	M18X1	20,5	25,5	25,5	30	18	57	22	22	90,5	10
9592 12-12-M24X1,5	12X1,5	12X1,5	7,5	6	M24X1,5	20,5	31	32,5	10	2,5	46	27	28	113	10
9592 15-15-M28X1,5	15X1,5	15X1,5	7	6	M28X1,5	25	34,5	37	13	2,5	52	30	32	158	10

Connectors Mod. 9580

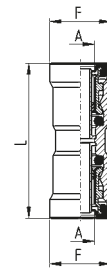

CHARACTERISTICS						
Mod.	A	F	L	Weight (g)	Pack. (pcs)	
9580 6	6x1	14	37,5	21	10	
9580 8	8x1	16	41	27	10	
9580 10/7	10x1,5	18	44	34	10	
9580 10	10x1	18	44	33	10	
9580 12	12x1,5	20	45,5	43	10	
9580 15/11	15x2	24	52	87	10	
9580 15	15x1,5	24	52	87	10	
9580 16/12	16x2	25	58	100	10	
9580 18	18x2	27	57	109	10	

Shaped non-swivel connectors

Elbow fittings Mod. 9502

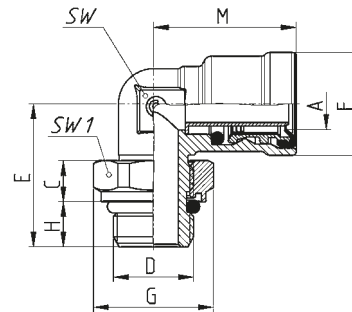

CHARACTERISTICS													
Mod.	A	C	D	E	F	G	H	M	SW	SW1	Weight (g)	Pack. (pcs)	
9502 6-M10X1R	6x1	6	M10X1	22	14,5	16	7*	22,5	9	14	25	10	
9502 6-M12X1,5R	6x1	8,2	M12X1,5	25	14,5	19	9	22,5	9	17	34	10	
9502 6-M16X1,5R	6x1	8,2	M16X1,5	26	14,5	24	9	23	11	22	46,5	10	
9502 6-M22X1,5R	6x1	8,2	M22X1,5	29	14,5	30	9	23	11	27	60	10	
9502 8-M10X1R	8x1	6	M10X1	23	16,5	16	7*	25	11	14	30,5	10	
9502 8-M12X1,5R	8x1	8,2	M12X1,5	26	16,5	19	9	25	11	17	39,5	10	
9502 8-M14X1,5R	8x1	8,2	M14X1,5	26	16,5	21	9	25	11	19	40	10	
9502 8-M16X1,5R	8x1	8,2	M16X1,5	26	16,5	24	9	25	11	22	45,5	10	
9502 8-M22X1,5R	8x1	8,2	M22X1,5	29	16,5	30	9	25	11	27	60	10	
9502 10/7-M12X1,5R	10x1,5	8,2	M12X1,5	27	18,5	19	9	27	13	17	48	10	
9502 10/7-M16X1,5R	10x1,5	8,2	M16X1,5	27,5	18,5	24	9	27	13	22	55,5	10	
9502 10/7-M22X1,5R	10x1,5	8,2	M22X1,5	29	18,5	30	9	27	13	27	69,3	10	
9502 10-M12X1,5R	10x1	8,2	M12X1,5	27	18,5	19	9	27	13	17	47	10	
9502 10-M16X1,5R	10x1	8,2	M16X1,5	27,5	18,5	24	9	27	13	22	54	10	
9502 10-M22X1,5R	10x1	8,2	M22X1,5	29	18,5	30	9	27	13	27	68	10	
9502 12-M12X1,5R	12x1,5	8,2	M12X1,5	28,5	20,5	19	9	28,5	15	17	55,5	10	
9502 12-M16X1,5R	12x1,5	8,2	M16X1,5	28,5	20,5	24	9	28,5	15	22	59,5	10	
9502 12-M22X1,5R	12x1,5	8,2	M22X1,5	30	20,5	30	9	28,5	15	27	72,5	10	
9502 15/11-M16X1,5R*	15x2	8,2	M16X1,5	31,5	24,5	24	9	34	18	22	94	10	
9502 15/11-M22X1,5R*	15x2	8,2	M22X1,5	34	24,5	30	9	34	18	27	106	10	
9502 15-M16X1,5R	15x1,5	8,2	M16X1,5	31,5	24,5	24	9	34	18	22	91	10	
9502 15-M22X1,5R	15x1,5	8,2	M22X1,5	34	24,5	30	9	34	18	27	103	10	
9502 16/12-M16X1,5R	16x2	8,2	M16X1,5	33	25	24	9	35,5	21	22	114	10	
9502 16/12-M22X1,5R	16x2	8,2	M22X1,5	33	25	30	9	35,5	21	27	117,5	10	
9502 16-M22X1,5R	16x1,5	8,2	M22X1,5	33	25	30	9	35,5	21	27	117,5	10	
9502 18-M22X1,5R	18x2	8,2	M22X1,5	33	27,5	30	9	35,5	21	27	115	10	

* on request only. The previous version is available while stocks last.

Elbow fittings Mod. 9500

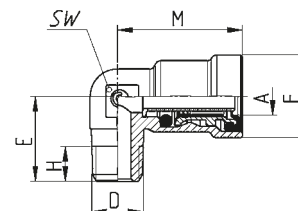

CHARACTERISTICS										
Mod.	A	D	E	F	H (min)	M	SW	Weight (g)	Pack. (pcs)	
9500 6-02	6x1	1/8 NPTF	17,5	14,5	8,5	21,5	9	18	10	
9500 05-02	8x1	1/8 NPTF	17	16,5	7	25	11	23	10	
9500 12-06	12x1,5	3/8 NPTF	24,5	20,5	10,5	28,5	15	46	10	

Te fittings Mod. 9412

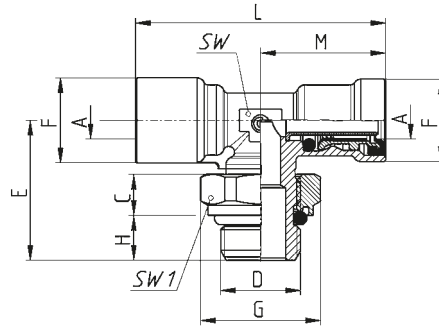

CHARACTERISTICS													
Mod.	A	C	D	E	F	G	H	L	M	SW	SW1	Weight (g)	Pack. (pcs)
9412 6-M10X1R	6x1	6	M10X1	23	14,5	16	7	45	22,5	9	14	38	10
9412 6-M12X1,5R	6x1	8,2	M12X1,5	27,5	14,5	19	9	46	23	11	17	57	10
9412 6-M16X1,5R*	6x1	8,2	M16X1,5	28	14,5	24	9	46	23	11	22	64,5	10
9412 6-M22X1,5R	6x1	8,2	M22X1,5	32	14,5	30	9	49	24,5	15	27	87	10
9412 8-M12X1,5R	8x1	8,2	M12X1,5	27,5	16,5	19	9	50	25	11	17	59,5	10
9412 8-M16X1,5R	8x1	8,2	M16X1,5	28	17	24	9	50	25	11	22	67	10
9412 8-M22X1,5R	8x1	8,2	M22X1,5	32	16,5	30	9	53	26,5	15	27	95,5	10
9412 10/7-M12X1,5R*	10x1,5	8,2	M12X1,5	29	18,5	19	9	55	27,5	15	17	86	10
9412 10/7-M16X1,5R*	10x1,5	8,2	M16X1,5	29	18,5	24	9	55	27,5	15	22	91	10
9412 10/7-M22X1,5R*	10x1,5	8,2	M22X1,5	32	18,5	30	9	55	27,5	15	27	103	10
9412 10-M12X1,5R	10x1	8,2	M12X1,5	29	18,5	19	9	55	27,5	15	17	83	10
9412 10-M16X1,5R	10x1	8,2	M16X1,5	29	18,5	24	9	55	27,5	15	22	88	10
9412 10-M22X1,5R	10x1	8,2	M22X1,5	32	18,5	30	9	55	27,5	15	27	100,5	10
9412 12-M12X1,5R	12x1,5	8,2	M12X1,5	29	20,5	19	9	57	28,5	15	17	77	10
9412 12-M16X1,5R*	12x1,5	8,2	M16X1,5	29	20,5	24	9	57	28,5	15	22	83	10
9412 12-M22X1,5R	12x1,5	8,2	M22X1,5	32	20,5	30	9	57	28,5	15	27	95,5	10
9412 15/11-M16X1,5R*	15x2	8,2	M16X1,5	33,5	24,5	24	9	68	34	18	22	135,5	10
9412 15/11-M22X1,5R	15x2	8,2	M22X1,5	34	24,5	30	9	68	34	18	27	146,5	10
9412 15-M16X1,5R	15x1,5	8,2	M16X1,5	33,5	24,5	24	9	68	34	18	22	129,5	10
9412 15-M22X1,5R*	15x1,5	8,2	M22X1,5	34	24,5	30	9	68	34	18	27	140,5	10

* on request only. The previous version is available while stocks last.

Te fittings Mod. 9410

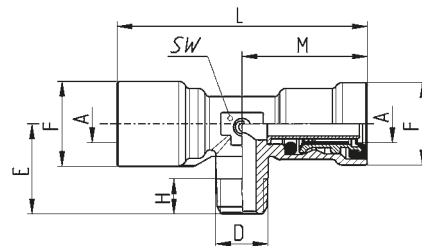

CHARACTERISTICS										
Mod.	A	D	E	F	H	L	M	SW1	Weight (g)	Pack. (pcs)
9410 6-02	6x1	1/8 NPTF	17,5	14,5	7	45	22,5	9	30,5	10
9410 05-02*	8x1	1/8 NPTF	18	17	7	50	25	11	42	10

* on request only. The previous version is available while stocks last.

Te fittings Mod. 9422

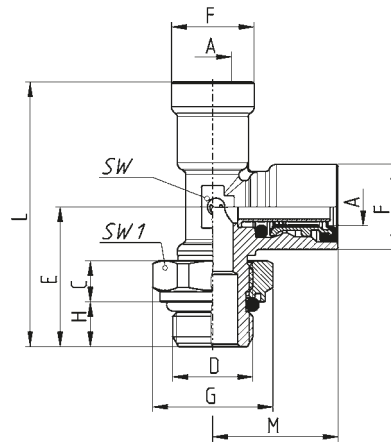

SERIES 9000

CHARACTERISTICS													
Mod.	A	C	D	E	F	G	H	L	M	SW	SW1	Weight (g)	Pack. (pcs)
9422 6-M10X1R	6x1	6	M10X1	23	14,5	16	7	45,5	22,5	9	14	37,5	10
9422 6-M12X1,5R	6x1	8,2	M12X1,5	27,5	14,5	19	9	50,5	23	11	17	57	10
9422 6-M16X1,5R*	6x1	8,2	M16X1,5	28	14,5	24	9	51	23	11	22	63,5	10
9422 8-M12X1,5R	8x1	8,2	M12X1,5	27,5	17	19	9	52,5	25	11	17	59,5	10
9422 8-M16X1,5R	8x1	8,2	M16X1,5	28	17	24	9	53	25	11	22	67	10
9422 8-M22X1,5R	8x1	8,2	M22X1,5	32	16,5	30	9	58,5	26,5	15	27	95	10
9422 10-M16X1,5R	10x1	8,2	M16X1,5	29	18,5	24	9	56,5	27,5	15	22	88	10
9422 10-M22X1,5R	10x1	8,2	M22X1,5	32	18,5	30	9	59,5	27,5	15	27	100	10
9422 12-M12X1,5R*	12x1,5	8,2	M12X1,5	29	20,5	19	9	57,5	28,5	15	17	78	10
9422 12-M16X1,5R	12x1,5	8,2	M16X1,5	29	20,5	24	9	57,5	28,5	15	22	83	10
9422 12-M22X1,5R	12x1,5	8,2	M22X1,5	32	20,5	30	9	60,5	28,5	15	27	99,5	10
9422 15-M16X1,5R*	15x1,5	8,2	M16X1,5	33,5	24,5	24	9	67,5	34	18	22	130	10
9422 15-M22X1,5R*	15x1,5	8,2	M22X1,5	34	24,5	30	9	68	34	18	27	140,5	10

* on request only. The previous version is available while stocks last.

Te fittings Mod. 9420

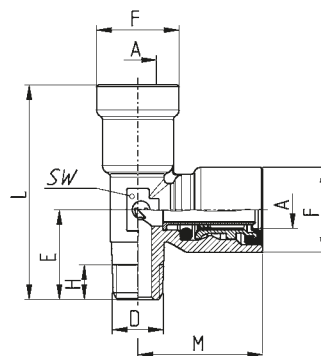

CHARACTERISTICS										
Mod.	A	D	E	F	H	L	M	SW	Weight (g)	Pack. (pcs)
9420 6-02	6x1	1/8 NPTF	17,5	14,5	7	40	22,5	9	30	10
9420 05-02*	8x1	1/8 NPTF	18	17	7	43	25	11	42	10

* on request only. The previous version is available while stocks last.

135° fittings Mod. 9102

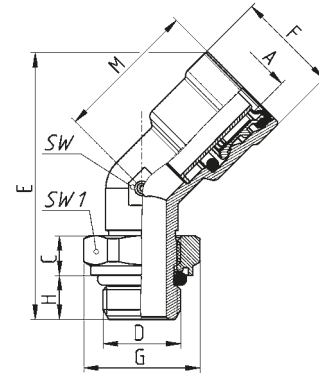

CHARACTERISTICS												
Mod.	A	C	D	E	F	G	H	M	SW	SW1	Weight (g)	Pack. (pcs)
9102 12-M16X1,5R**	12x1,5	8,2	M16X1,5	54,9	21,3	24	9	29,5	15	22	64	10

** on request only.

Tee fittings Mod. 9540

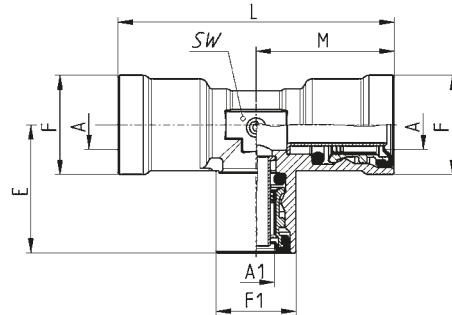

CHARACTERISTICS										
Mod.	A	A1	E	F	F1	L	M	SW	Weight (g)	Pack. (pcs)
9540 6	6x1	6x1	22,5	14,5	14,5	45	22,5	9	35,5	10
9540 8	8x1	8x1	25	17	17	50	25	11	53	10
9540 10/7*	10x1,5	10x1,5	27,5	18,5	18,5	55	27,5	15	84	10
9540 10	10x1	10x1	27,5	18,5	18,5	55	27,5	15	81	10
9540 12	12x1,5	12x1,5	28,5	20,5	20,5	57	28,5	15	73,5	10
9540 15/11*	15x2	15x2	34	24,5	24,5	68	34	18	137	10
9540 15	15x1,5	15x1,5	34	24,5	24,5	68	34	18	129	10
9540 8-8-6	8x1	6x1	23	17	14,5	50	25	11	50	10
9540 12-12-8	12x1,5	8x1	26,5	20,5	16,5	57	28,5	15	72	10

* on request only. The previous version is available while stocks last.

Fittings Mod. 9555

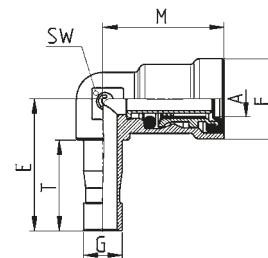

CHARACTERISTICS									
Mod.	A	G	T	E	F	M	SW	Weight (g)	Pack. (pcs)
9555 6-6	6x1	6	16,9	25	14,5	22,5	9	17	10
9555 8-8	8x1	8	18,7	27,2	16,5	25	11	23	10
9555 12-12	12x1,5	12	20,7	32,2	21	29,5	15	45	10

Y fittings Mod. 9450

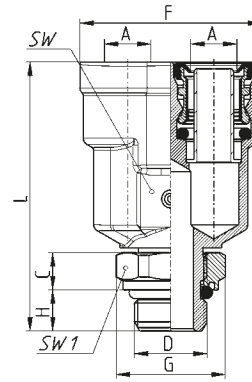

CHARACTERISTICS												
Mod.	A	C	D	F	G	H	L	SW	SW1	Weight (g)	Pack. (pcs)	
9450 8-M16X1,5R	8x1	8,2	M16X1,5	31,5	24	9	49,3	14	22	71,5	10	
9450 12-M16X1,5R*	12x1,5	8,2	M16X1,5	40	24	9	59,2	20	22	130,5	10	
9450 12-M22X1,5R	12x1,5	8,2	M22X1,5	40	30	9	59,2	20	27	133	10	

* on request only.

Elbow fittings Mod. 9402

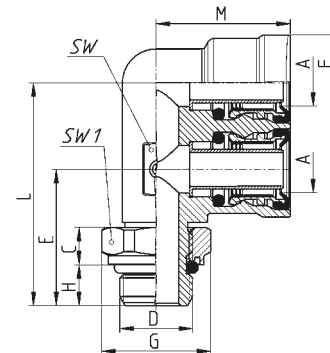

CHARACTERISTICS													
Mod.	A	C	D	E	F	G	H	L	M	SW	SW1	Weight (g)	Pack. (pcs)
9402 12-M16X1,5R*	12x1,5	8,2	M16X1,5	30	21	24	9	49	29,5	15	22	108	10
9402 12-M22X1,5R	12x1,5	8,2	M22X1,5	30	21	30	9	49	29,5	15	27	114,5	10

* on request only.

Swivel range

Swivel studs Mod. D2912

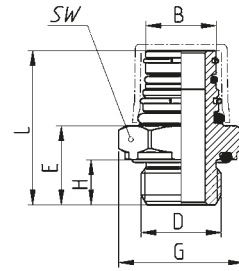

CHARACTERISTICS									
Mod.	B	D	E	G	H	L	SW	Weight (g)	Pack. (pcs)
D2912 C1-M10X1B	C1	M10X1	14,3	18,5	8	29,3	17	22	10
D2912 C1-M12X1,5B	C1	M12X1,5	14,5	20	9	29,5	18	22,5	10
D2912 C1-M14X1,5B	C1	M14X1,5	14,5	22	9	29,5	20	25	10
D2912 C1-M16X1,5B/1*	C1	M16X1,5	15,8	25	9	30,8	22	34	10
D2912 C1-M22X1,5B/1	C1	M22X1,5	16,3	32	9	31,3	28	48	10

* usable with Series 9707 anti-rotation ring.

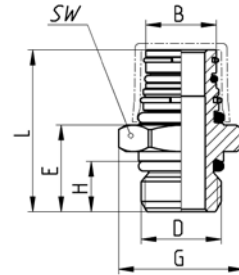

CHARACTERISTICS									
Mod.	B	D	E	G	H	L	SW	Weight (g)	Pack. (pcs)
D2912 C1-M10X1	C1	M10X1	14,3	18,5	7	29,3	17	24	10
D2912 C1-M12X1,5	C1	M12X1,5	17,3	18,5	10	32,3	17	27	10
D2912 C1-M14X1,5	C1	M14X1,5	17,3	18,5	10	32,3	17	29	10
D2912 C1-M16X1,5	C1	M16X1,5	17,3	18,5	10	32,3	17	31	10
D2912 C1-M16X1,5/1*	C1	M16X1,5	17,3	25	10	32,3	22	36	10
D2912 C1-M22X1,5/1*	C1	M22X1,5	17,3	27	10	32,3	24	44	10

Anti-rotation ring Mod. 9707

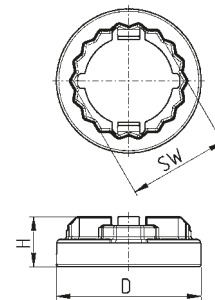

CHARACTERISTICS					
Mod.	H	D	SW	Weight (g)	Pack. (pcs)
9707 22-C1	11	31,7	22	4	10
9707 24-C1	11	31,7	24	4	10

Swivel elbow fittings Mod. 9520



To combine with D2912 models

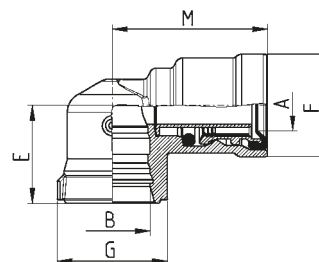

CHARACTERISTICS								
Mod.	A	B	E	F	G	M	Weight (g)	Pack. (pcs)
9520 6-C1	6x1	C1	19,5	14,5	22	26	32	10
9520 8-C1	8x1	C1	19,5	16,5	22	28	32	10
9520 10-C1	10x1	C1	19,5	18,5	22	30	42	10
9520 12-C1	12x1,5	C1	19,5	20,5	22	31	42	10
9520 15-C1	15x1,5	C1	21,5	24	22	34	62	10

Swivel tee fittings Mod. 9430



To combine with D2912 models

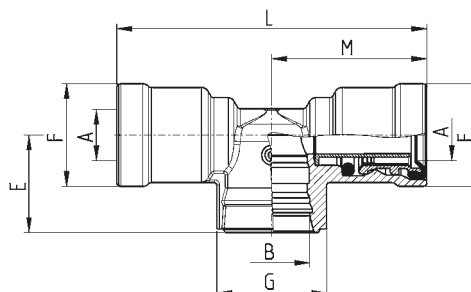

CHARACTERISTICS									
Mod.	A	B	E	F	G	L	M	Weight (g)	Pack. (pcs)
9430 6-C1	6x1	C1	19,5	14,5	22	4	2	46	10
9430 8-C1	8x1	C1	19,5	16,5	22	56	28	46	10
9430 10-C1	10x1	C1	19,5	18,5	22	60	30	64	10
9430 12-C1	12x1,5	C1	19,5	20,5	22	62	31	64	10
9430 15-C1	15x1,5	C1	21,5	24	22	68	34	101	10

Swivel tee fittings Mod. 9440



To combine with D2912 models

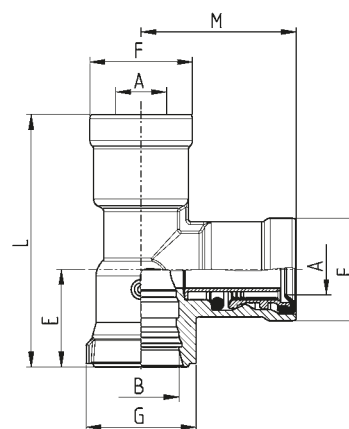

CHARACTERISTICS									
Mod.	A	B	E	F	G	L	M	Weight (g)	Pack. (pcs)
9440 6-C1	6x1	C1	19,5	14,5	22	45,5	26	47	10
9440 8-C1	8x1	C1	19,5	16,5	22	47,5	28	47	10
9440 10-C1	10x1	C1	19,5	18,5	22	49,5	30	67	10
9440 12-C1	12x1,5	C1	19,5	20,5	22	50,5	31	67	10
9440 15-C1	15x1,5	C1	21,5	24	22	55,5	34	100	10

Swivel elbow adaptors Mod. D2220



To combine with D2912 models

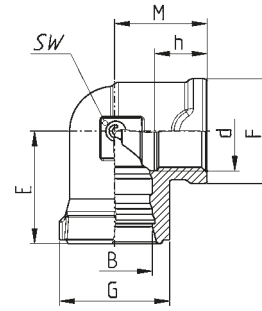

CHARACTERISTICS										
Mod.	d	B	E	F	G	h (min)	M	SW	Weight (g)	Pack. (pcs)
D2220 M12X1,5-C1	M12X1,5	C1	22,5	21	22	10,5	18,5	20	50	10
D2220 M16X1,5-C1	M16X1,5	C1	22,5	21	22	10,5	18,5	20	39	10

Swivel Tee adaptors Mod. D2260



To combine with D2912 models

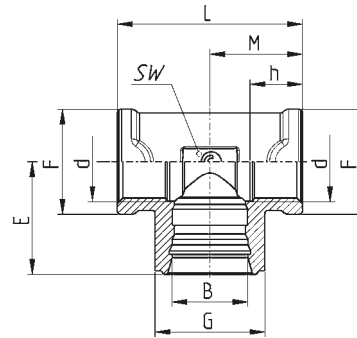

CHARACTERISTICS											
Mod.	d	B	E	F	G	h (min)	L	M	SW	Weight (g)	Pack. (pcs)
D2260 M12X1,5-C1	M12X1,5	C1	22,5	21	22	10,5	37	18,5	20	73	10
D2260 M16X1,5-C1	M16X1,5	C1	22,5	21	22	10,5	37	18,5	20	52	10

Swivel Tee adaptors Mod. D2270



To combine with D2912 models

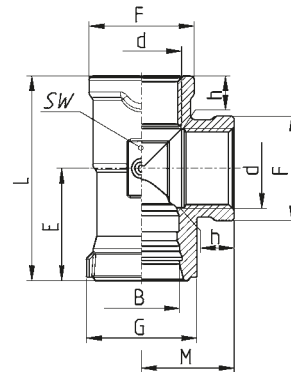

CHARACTERISTICS											
Mod.	d	B	E	F	G	h (min)	L	M	SW	Weight (g)	Pack. (pcs)
D2270 M12X1,5-C1	M12X1,5	C1	22,5	21	22	10,5	41	18,5	20	73	10
D2270 M16X1,5-C1	M16X1,5	C1	22,5	21	22	10,5	41	18,5	20	52	10

Adaptors & Valves

Bulkhead connectors Mod. D2502 and D2512

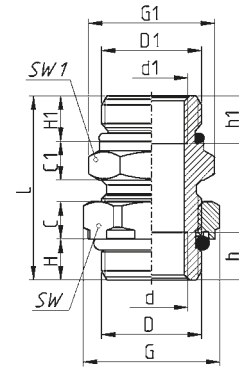

CHARACTERISTICS																		
Mod.	D	D1	d	d1	C	C1	G	G1	H	H1	h	h1	L	SW	SW1	Weight (g)	Pack. (pcs)	
D2502 M22X1,5R-M22X1,5R-M16X1,5-L=39	M22X1,5	M22X1,5	M16X1,5	M16X1,5	8,2	8,5	30	28	9	10	10,5	10,5	40,5	27	24	79,5	10	
D2502 M22X1,5R-M22X1,5R	M22X1,5	M22X1,5	-	-	8,2	8,5	30	28	9	10	-	-	40,5	27	24	84	10	
D2512 M22X1,5R-M16X1,5R	M22X1,5	M16X1,5	M16X1,5	M10X1	8,2	8,5	30	25,5	9	10	10,5	-	49,5	27	22	88	10	

Reducer Mod. D2532

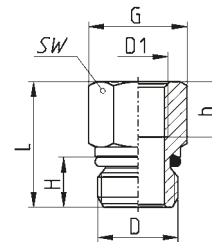

CHARACTERISTICS									
Mod.	D	D1	G	H	h	L	SW	Weight (g)	Pack. (pcs)
D2532 M16X1,5R-M12X1,5	M16X1,5	M12X1,5	20	10	11	25	17	25	10
D2532 M22X1,5R-M12X1,5	M22X1,5	M12X1,5	26,5	10	11	17,5	24	42,5	10
D2532 M22X1,5R-M16X1,5	M22X1,5	M16X1,5	26,5	10	10,5	17,5	24	31	10

Hose adaptors Mod. D2602

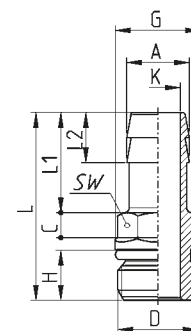

CHARACTERISTICS												
Mod.	A	D	C	G	H	L	L1	L2	K	SW	Weight (g)	Pack. (pcs)
D2602 10-M16X1,5R-L=30	11	M16X1,5	5	17	10	47,5	30	10	7,5	14	26,5	10
D2602 11,5-M16X1,5R-L=35	12,5	M16X1,5	5	17	10	52,5	35	10	9	14	27	10
D2602 12-M16X1,5R	12,5	M16X1,5	5	17	10	37,5	20	10	9	14	22	10
D2602 12-M22X1,5R	12,5	M22X1,5	5	23	10	38	20	10	9	14	35,5	10
D2602 13-M16X1,5-S01	15,5	M16X1,5	7	25,5	9	56	40	10	10	22	50	10

Elbow adaptors Mod. D2022

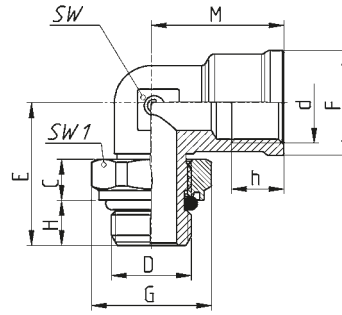

CHARACTERISTICS

Mod.	d	D	C	E	F	G	H	h	M	SW	SW1	Weight (g)	Pack. (pcs)
D2022 M16X1,5-M16X1,5R	M16X1,5	M16X1,5	8,2	28,5	21	24	9	10,5	26,5	15	22	60,5	10
D2022 M16X1,5-M22X1,5R	M16X1,5	M22X1,5	8,2	30	21	30	9	10,5	26,5	15	27	71	10
D2022 M22X1,5-M22X1,5R	M22X1,5	M22X1,5	8,2	33	27	30	9	11	22	24	27	88	10

Tee adaptors Mod. D2062

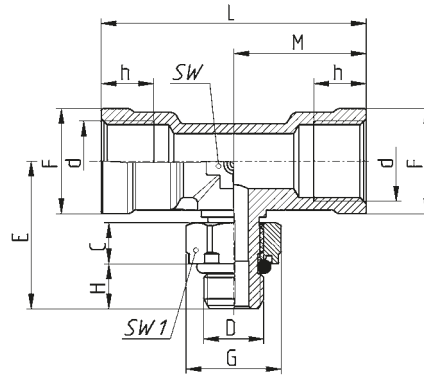

CHARACTERISTICS

Mod.	d	D	C	E	F	G	H	h	L	M	SW	SW1	Weight (g)	Pack. (pcs)
D2062 M16X1,5-M12X1,5R	M16X1,5	M12X1,5	8,2	29,5	21	19	9	10,5	53	26,5	15	17	77	10
D2062 M16X1,5-M16X1,5R	M16X1,5	M16X1,5	8,2	30	21	24	9	12,5	37	18,5	20	22	70	10
D2062 M16X1,5-M22X1,5R	M16X1,5	M22X1,5	8,2	32	21	30	9	10,5	37	18,5	20	27	84,5	10
D2062 M22X1,5-M22X1,5R	M22X1,5	M22X1,5	8,2	33	27	30	9	11	64	32	20	27	131	10

Tee adaptors Mod. D2072

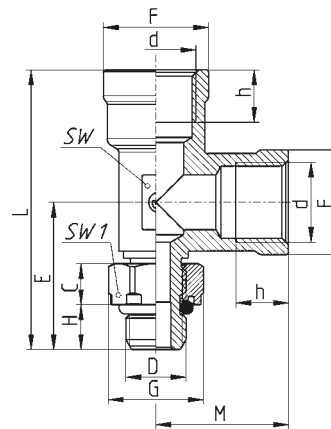

CHARACTERISTICS

Mod.	d	D	C	E	F	G	H	h	L	M	SW	SW1	Weight (g)	Pack. (pcs)
D2072 M16X1,5-M12X1,5R	M16X1,5	M12X1,5	8,2	29,5	21	19	9	10,5	56	26,5	15	17	75	10
D2072 M16X1,5-M16X1,5R	M16X1,5	M16X1,5	8,2	30	21	24	9	10	48,5	18,5	20	22	70	10
D2072 M16X1,5-M22X1,5R	M16X1,5	M22X1,5	8,2	32	21	30	9	10	50,5	18,5	20	27	82	10
D2072 M22X1,5-M22X1,5R	M22X1,5	M22X1,5	8,2	33	27	30	9	11	65	32	20	27	131	10

Tee adaptors Mod. D2003

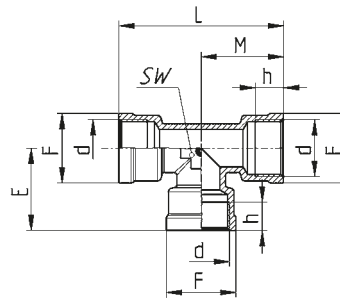

CHARACTERISTICS													
Mod.	d	E	G	h	M	L	N	O	P	R	SW	Weight (g)	Pack. (pcs)
D2003 M16X1,5	M16X1,5	18,5	21	10	18,5	37	-	-	-	-	20	53	10
D2003 M22X1,5	M22X1,5	32	27	11	32	64	-	-	-	-	20	126,5	10

Tee adaptors Mod. D2003...S01

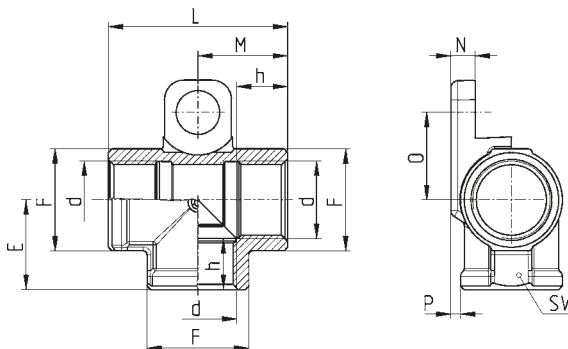

CHARACTERISTICS													
Mod.	d	E	G	h	M	L	N	O	P	R	SW	Weight (g)	Pack. (pcs)
D2003 M16X1,5-S01	M16X1,5	18,5	21	10,5	18,5	37	5	18	2	9	21	68	10

Cross adaptors Mod. D2032

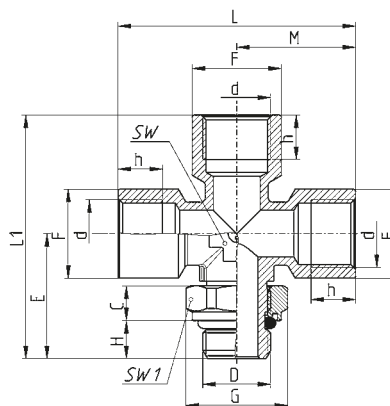

CHARACTERISTICS															
Mod.	d	D	C	E	F	G	H	h	L	L1	M	SW	SW1	Weight (g)	Pack. (pcs)
D2032 M16X1,5-M16X1,5R	M16X1,5	M16X1,5	8,2	29,5	21	24	9	10,5	56	57,5	28	16	22	110,5	10

Bilateral tee adaptors Mod. D2077

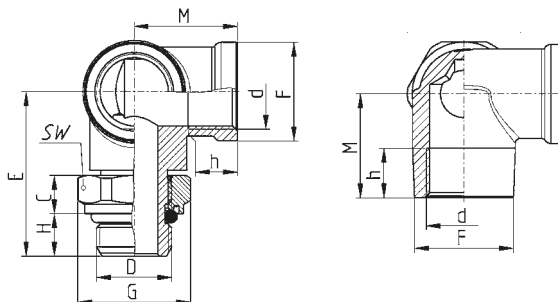

CHARACTERISTICS													
Mod.	D	d	C	E	F	G	H	h	M	SW	Weight (g)	Pack. (pcs)	
D2077 M16X1,5-M16X1,5R	M16X1,5	M16X1,5	8,2	35	21	24	9	10,5	22	22	94,5	10	
D2077 M16X1,5-M22X1,5R	M22X1,5	M16X1,5	8,2	35,5	21	30	9	10,5	22	27	98	10	

Adaptor Mod. D3043

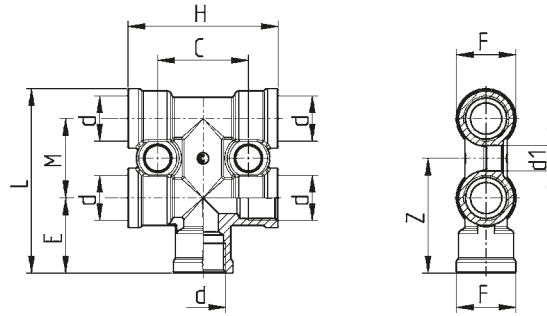

CHARACTERISTICS

Mod.	d	d1	C	E	M	L	H	G	Z	Weight (g)	Pack. (pcs)
D3043 M16X1,5-2D-M16X1,5-S01	M16X1,5	9	32	26,5	28	65	53	21	40,5	147	10

Taps Mod. D2612

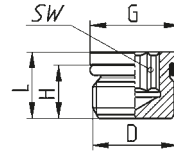

CHARACTERISTICS

Mod.	D	H	L	G	SW	Weight (g)	Pack. (pcs)
D2612 M12X1,5R	M12X1,5	10	12	13	6	6,5	10
D2612 M16X1,5R	M16X1,5	10	12,5	17	8	13	10
D2612 M22X1,5R	M22X1,5	10	13	23	12	26	10

Test point valve Mod. VPC2

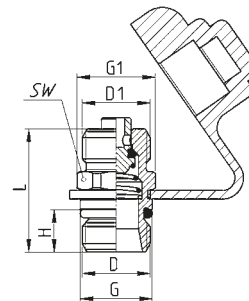

CHARACTERISTICS

Mod.	D	D1	H	G	G1	L	SW	Weight (g)	Pack. (pcs)
VPC2 M16X1,5R-M16X1,5	M16X1,5	M16X1,5	10	17	18,5	29	17	33	10
VPC2 M22X1,5R-M16X1,5	M22X1,5	M16X1,5	10	23	18,5	29	17	41	10

Bulkhead with test point & tube connection Mod. VPC2

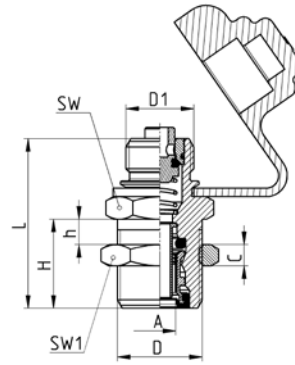

CHARACTERISTICS											
Mod.	A	D	D1	C	H	h	L	SW	SW1	Weight (g)	Pack. (pcs)
VPC2 M16X1,5-8-M18X1,5	8X1	M18X1,5	M16X1,5	5,5	21	2,5	40	20	22	61	10
VPC2 M16X1,5-8-M20X1,5	8X1	M20X1,5	M16X1,5	5	21	2,5	40	22	24	71	10

Drain valve Mod. VDC2

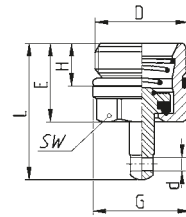

CHARACTERISTICS										
Mod.	D	d	E	G	H	L	SW	Weight (g)	Pack. (pcs)	
VDC2 M22X1,5R	M22X1,5	3,2	18,5	23	10	32,1	19	29	10	

Tyre inflator valve Mod. V604



A = rod position for tyre inflation
B = rod position for tank filling through air intake for tyre inflation

2 = energy supply
3 = drain
11, 12 = energy flow

Flow 2 ÷ 11 bar at 6 bar ΔP 1: 1620 l/min
Flow 2 ÷ 12 bar at 6 bar with no interruption: 400 l/min
Safety pressure: 10 bar Q = 100 l/min; 8 bar Q = 0 l/min

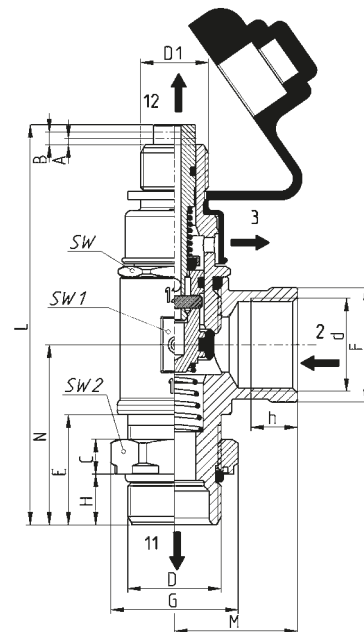

CHARACTERISTICS																	
Mod.	C	D	D1	d	E	F	G	H	h	L	M	N	SW	SW1	SW2	Weight (g)	Pack. (pcs)
V604 M22X1,5R	8,2	M22X1,5	M16X1,5	M22X1,5	26	27	30	12	11	94,4	29	42,5	24	27	27	253	2

Accessories

■ Tubes Mod. TRN



Black tubes in polyamide (PA12)

According to standards:

- DIN 74324 (except for Mod. TRN 16/13 NX)
- REACH REGULATION (EC N°1907/2006)
- EUROPEAN DIRECTIVE RoHS n° 2002/95/EC

SERIES 9000

CHARACTERISTICS						
Mod.	D/d	MAX pressure at 23°C (bar)	Weight (g/m)	Min. curve radius min. (mm)	Operating temperature (°C)	Size (m)
TRN 4/2 NX	4/2	49	9.6	16	-55°C ++100°C	50
TRN 6/4 NX	6x1	29	16	30	-55°C ++100°C	100
TRN 8/6 NX	8x1	21	22.4	40	-55°C ++100°C	100
TRN 10/8 NX	10x1	16	28.8	60	-55°C ++100°C	50
TRN 12/9 NX	12x1,5	21	50.4	60	-55°C ++100°C	50
TRN 15/12 NX	15x1,5	16	64.9	90	-55°C ++100°C	50
TRN 16/13 NX	16x1,5	13	71	120	-55°C ++100°C	50
TRN 18/14 NX	18x2	18	102.5	100	-55°C ++100°C	50

■ Tube disconnecting key Mod. DRK



Material: technopolymer

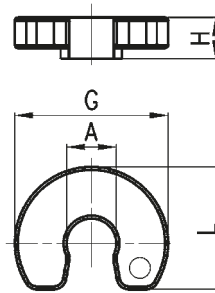

CHARACTERISTICS						
Mod.	A	G	H	L	Weight (g)	Pack. (pcs)
DRK 6	6	25	6	19	1	10
DRK 8	8	28.5	7	20	1	10
DRK 10	10	30.5	9	22	2	10
DRK 12	12	35	9	23	3	10
DRK 15	15	36	10	27	3	10
DRK 16	16	37	10	27.5	4	10
DRK 18	18	40	12	31	5	10

■ Tube cutter tool Mod. PNZ and PNZP



CHARACTERISTICS	
Mod.	
PNZ-12	able to cut tubes with Ø up to 12 mm
PNZ-25	able to cut tubes with Ø up to 25 mm
PNZP-12	able to cut tubes with Ø up to 12 mm

Assortment boxes / Repair Kits

For the pneumatic system of commercial vehicles and trailers.

Air brake & Airsuspension > Series 9000 Accessories > Series 6000

The TRUCK-DCASE kits enable drivers to repair tube damages or other smaller issues on the connections when being out on the road or in the field and professional repair/ maintenance is out of reach.

These repair kits contain fittings in the most common sizes, the necessary release tools, as well as a tube cutting device.

The TRUCK-DCASE also contains concise user instructions.

MODEL TRUCK-DCASE/6000

Repair kit with Series 6000 fittings

The kit is supplied with:

2x 6580 4	2x 6580 10	1x PNZP-12
2x 6580 5	1x 6580 12	
2x 6580 6	1x 6580 14	
2x 6580 8		

NOTE: the 6000 fittings are only for use in auxiliary applications (no airbrake, no suspension, no powertrain).



MODEL TRUCK-DCASE/9000

Repair kit with Series 9000 fittings

The kit is supplied with:

2x 9580 6	1x DRK 6	1x PNZP-12
2x 9580 8	1x DRK 8	
2x 9580 10	1x DRK 10	
2x 9580 12	1x DRK 12	



MODEL TRUCK-DCASE/9000+6000

Repair kit with Series 9000 and Series 6000 fittings

The kit is supplied with:

1x 6580 4	2x 6580 10	2x 9580 6	1x DRK 6
1x 6580 5	1x 6580 12	2x 9580 8	1x DRK 8
1x 6580 6	1x 6580 14	1x 9580 10	1x DRK 10
1x 6580 8		1x 9580 12	1x DRK 12
			1x PNZP-12

NOTE: the 6000 fittings are only for use in auxiliary applications (no airbrake, no suspension, no powertrain).



WELCOME TO CAMOZZI AUTOMATION

Product Preview:

Series 9000 for extra corrosive environment

Scan the QR-code and read more

www.camozzi.com/case-studies/horsch-leebe.kl

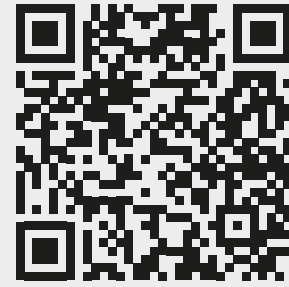

Fitting Series:

- **Series 1000**
Brass universal nose fittings
- **Series 2000**
Brass adaptors
- **Series 5000**
Quick release couplings
- **Series 6000**
Single seal brass super-rapid fittings
- **Series 6000 HP**
Single seal brass super-rapid fittings for lubrication
- **Series 7000**
Single seal composite super-rapid fittings
- **Series 8000/H8000**
Dual seal brass super-rapid fittings
- **Series 9000**
Dual seal brass airbrake fittings
(metric/collet design)
- **Series ND**
Single seal brass airbrake fittings
(Inch/collet design)



More Product Lines:



■ VALVES AND SOLENOID VALVES



■ PNEUMATIC ACTUATION



■ AIR TREATMENT



TIRCO BVBA

Waterrijtstraat 45
3920 Lommel
Belgium

Telefoon : +32 (0)11 561810
Fax : +32 (0)11 561811
email : info@tirco.com
Website : www.tirco.com

VAT: BE0879.624.902

